

# INSTALLATION INSTRUCTIONS

203041 / 203041-2

## 2011 FORD EXPLORER

### PARTS LIST:

Qty	Description	Qty	Description
1	Driver/Left Side Bar	2	12mm x 40mm Bolt & Tabs
1	Passenger/Right Side Bar	6	10mm x 35mm Bolt & Tabs
1	Driver/Left Front Mounting Bracket	18	10mm ID x 30mm OD Flat Washer
1	Passenger/Right Front Mounting Bracket	16	10mm Lock Washer
1	Driver/Left Rear Mounting Bracket	8	10mm Hex Nut
1	Passenger/ Rear Mounting Brace Bracket	10	10mm x 35mm Hex Bolt
1	Driver/Left Front Brace Bracket	2	12mm ID x 31mm OD Flat Washer
1	Passenger/ Front Brace Bracket	2	12mm Lock Washer
2	12MM Plastic Retainers	2	12mm Hex Nut
6	9MM Plastic Retainers		

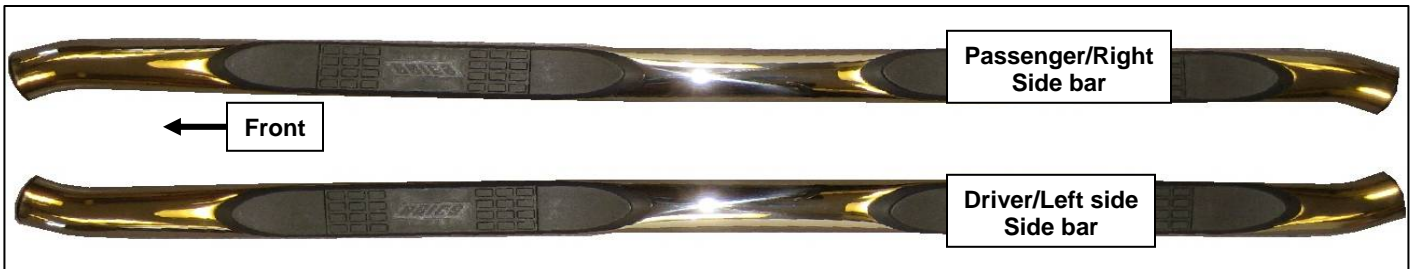

Driver Front Mounting Brackets

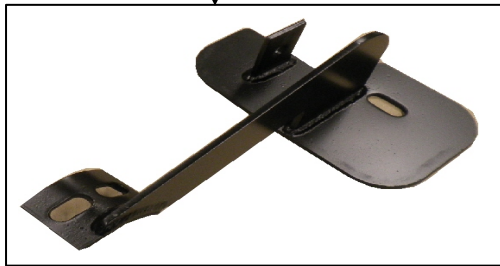

Driver Rear Mounting Bracket



Driver Front Brace Brackets

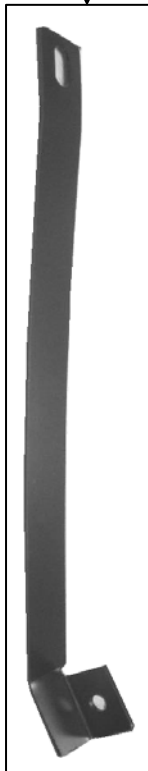

Passenger Front Brace Brackets

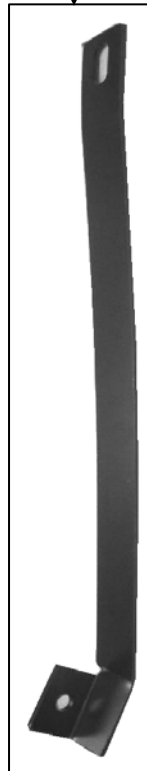

Passenger Front Mounting Brackets

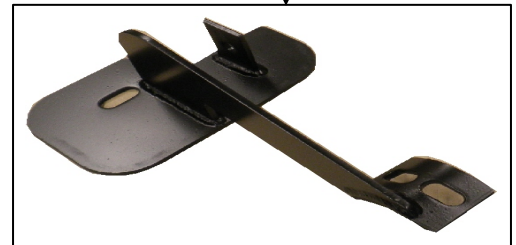

Passenger Rear Mounting Bracket



12mm x 40mm Bolt Tab  
(pictured with Plastic Retainer installed for example)



10mm x 35mm Bolt Tab  
(pictured with Plastic Retainer installed for example)



## PROCEDURE:

- 1. REMOVE CONTENTS FROM BOX. VERIFY ALL PARTS ARE PRESENT. READ INSTRUCTIONS CAREFULLY BEFORE STARTING INSTALLATION.**
- Starting with the Driver/Left side-front of the vehicle, locate the mounting hole in the floor board as seen in **(Fig 1)**, From the list above select the 10mm Bolt tab & plastic retainer. Thread the Plastic Retainer onto the threaded end of a Bolt tab; Insert the Bolt tab into the factory hole. **(Fig 1A)**. Once the Bolt tab is inserted, hold the Bolt end with one hand and tighten the Plastic Retainer with your other hand, **(NOTE: Tighten the Plastic Retainer until it reaches the floor board.**
- Next select the Driver/Left side front mounting bracket and secure it to the 10mm bolt tab with (1) 10mm flat washer, (1) 10mm Lock Washers & (1) 10mm Nut **(Fig 2)**. Snug but do not tighten hardware at this time. With the mount bracket attached, select the front Driver/side brace brackets & the 12mm bolt tab from the list of parts above, Thread the Plastic Retainer onto the threaded end of a Bolt tab; Insert the Bolt tab into the factory hole on the bottom of the frame rail. **(Fig 2A)**. Once the Bolt tab is inserted, hold the Bolt end with one hand and tighten the Plastic Retainer with your other hand, **(NOTE: Tighten the Plastic Retainer until it reaches the bottom of the frame rail.**
- Select the Driver/Left front brace bracket and Secure Brace Bracket to Bolt tab with (1) 12mm flat washer, (1) 12mm lock washer and (1) 12mm nut. Next attach to Mounting bracket with (1) 10mm Hex Bolt, (2) 10mm flat washer, (1) 10mm lock washer and (1) 10mm nut. **(Fig 2)** shows front of brace bracket attached to mount bracket **(Fig 2B)** shows brace bracket attached to bolt tab. Snug but do not tighten hardware at this time.
- Moving to the Driver/Left side rear of the vehicle, locate the 2 holes in bottom of floor boards as seen in **(Fig 3)**, From the list above select the 10mm Bolt tabs & plastic retainer. Thread the Plastic Retainers onto the threaded end of each Bolt tabs; Insert the Bolt tabs into the factory holes. **(Fig 3A)**. Once each Bolt tab is inserted, hold the Bolt end with one hand and tighten the Plastic Retainer with your other hand, **(NOTE: Tighten the Plastic Retainer until it reaches the floor board.**
- Select the Driver side rear Mount Bracket, and Position the mount Bracket onto the installed Bolt tabs. Secure it with (2) 10mm Flat Washer, (2) 10mm Lock Washer and (2) 10mm Hex Nut, **(Fig 4)**. Snug but do not tighten hardware at this time.
- Install Sidebar to the mounting brackets with (4) 10mm hex bolt, (4) 10mm lock washer, and (4) 10mm flat washer. **(Fig 5 & 6)** shows Mounting Bracket attached snug but do not tighten hardware at this time.
- Level and align Sidebar properly; then tighten all hardware at this time.
- Repeat steps 2-7 for Passenger Sidebar.
- Do periodic inspections to the installation to make sure all hardware is secure and tight.

**To protect your investment**, wax this product after installing. Regular waxing is recommended to add a protective layer over the finish. Do not use any type of polish or wax that may contain abrasives that could damage the finish.

**For stainless steel:** Aluminum polish may be used to polish small scratches and scuffs on the finish. Mild soap may be used also to clean the Product.

**For gloss black finishes:** Mild soap may be used to clean the Product.

***DRIVER SIDE INSTALLATION PICTURED***

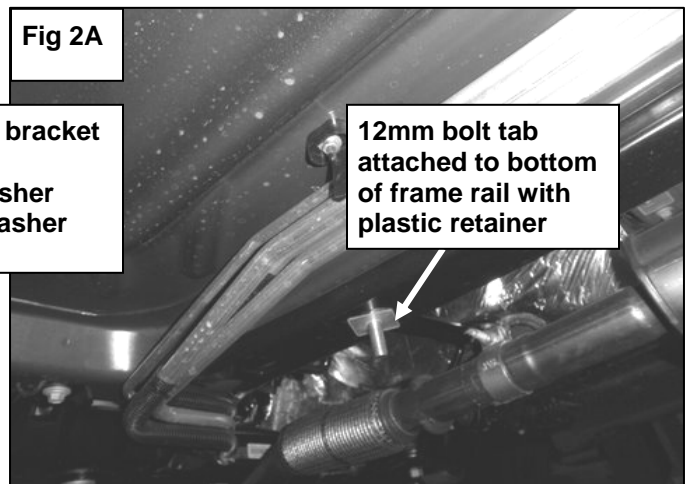
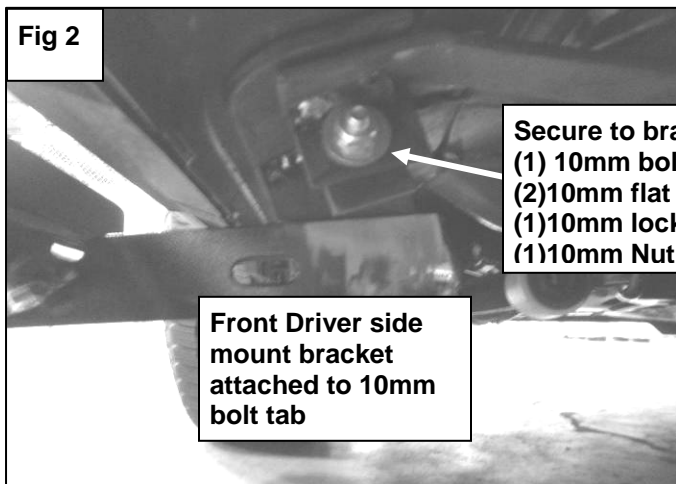
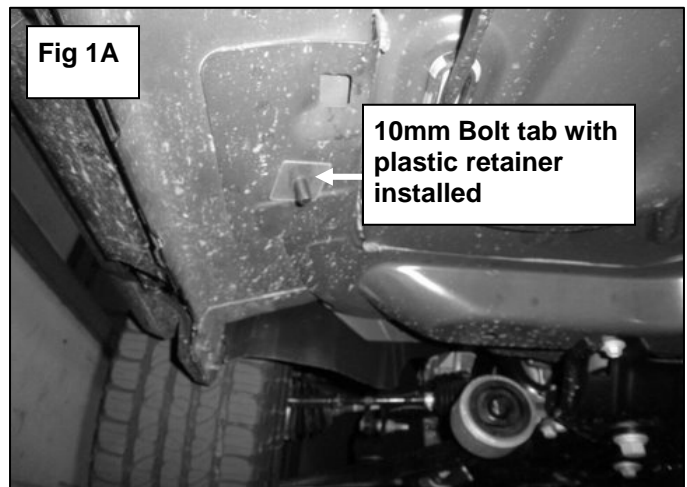
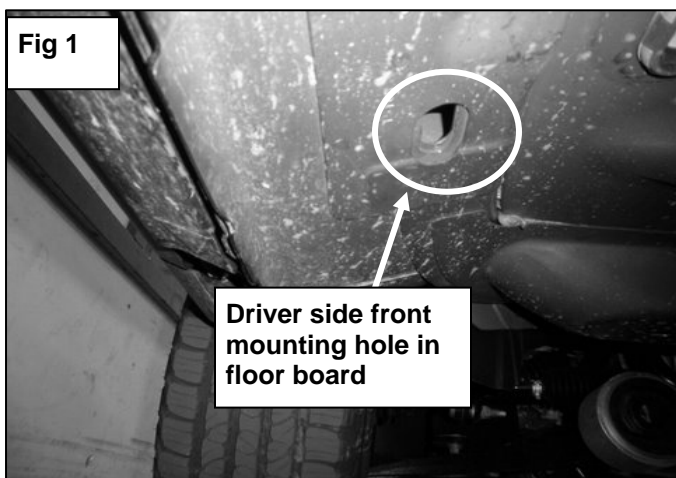

Secure to brace bracket  
(1) 10mm bolt  
(2)10mm flat washer  
(1)10mm lock washer  
(1)10mm Nut

