

INSTALLATION INSTRUCTIONS

235030/235030-2

2010 DODGE RAM 2500/3500 MEGA CAB

PARTS LIST:

Qty	Description	Qty	Description
1	Driver/Left Sidebar	2	Plastic Retainers
1	Passenger/Right Sidebar	2	10mm x 35mm T Bolts
1	Driver/Left Front Mounting Bracket	4	10mm x 35mm Bolts
1	Passenger/Right Front Mounting Bracket	6	10mm Lock Washers
1	Driver/Left Rear Mounting Bracket	10	10mm Flat Washers
1	Passenger/Right Rear Mounting Bracket	4	10mm Nuts
1	Driver/Left Middle support bracket	4	12mm x 50mm Hex Bolts
1	Passenger/Right Middle support bracket	4	12mm Lock Washers
2	1 1/8" Spacer Blocks	4	12mm Flat Washers
4	12mm x 150mm Hex Bolts	2	10mm x 35mm Bolt Plates

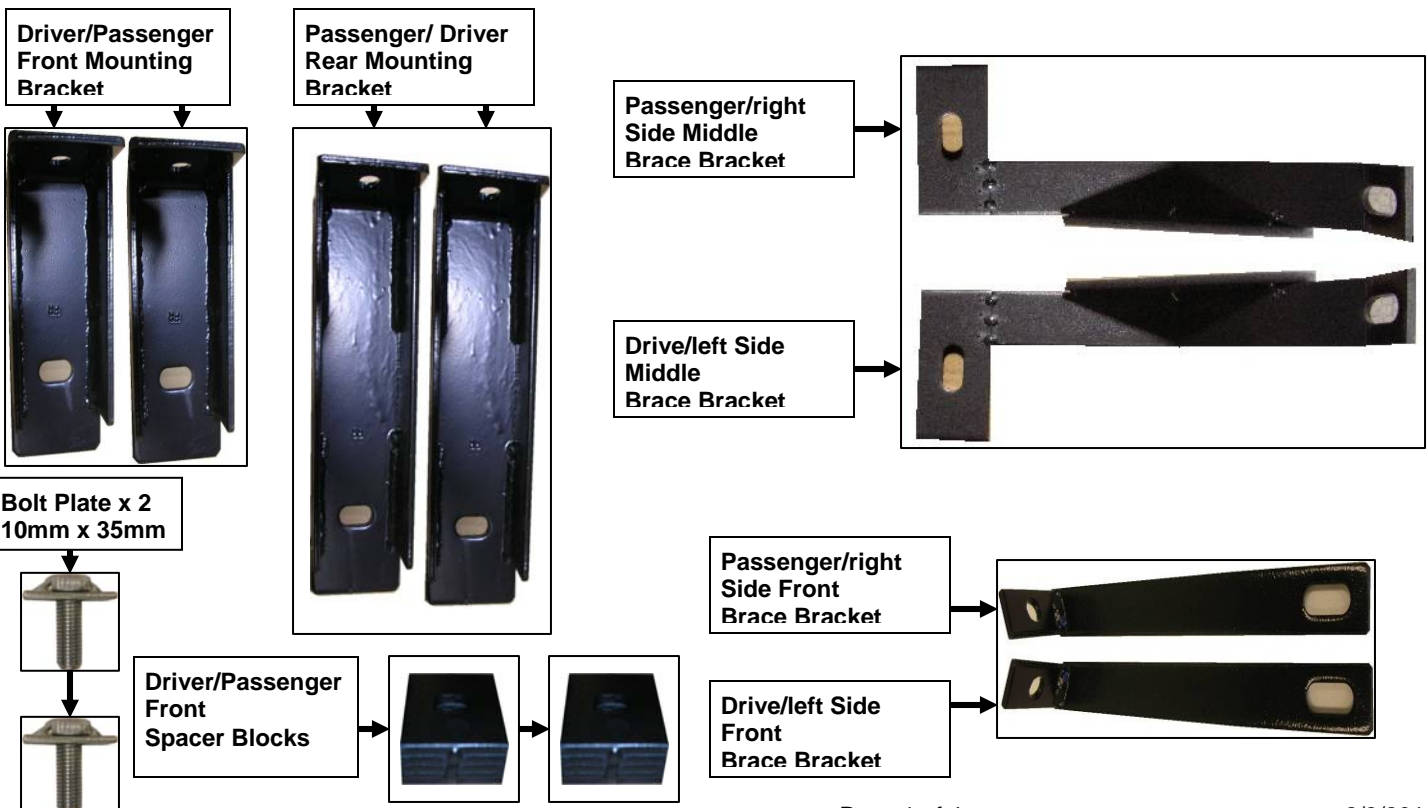
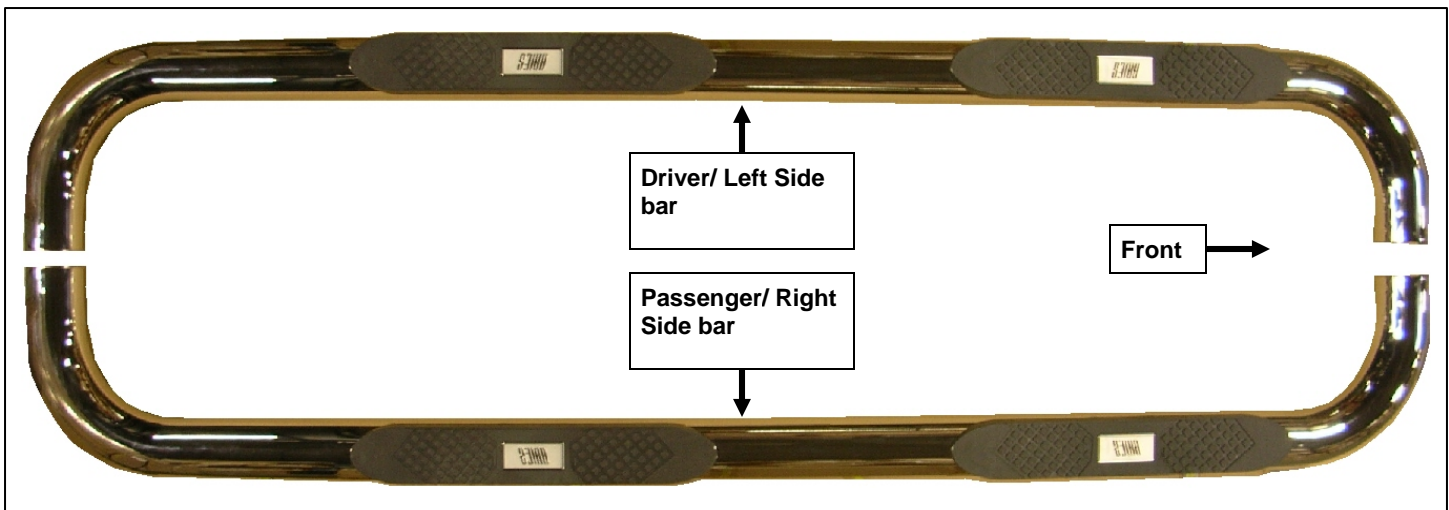

PROCEDURE:

- 1. REMOVE CONTENTS FROM BOX. VERIFY ALL PARTS ARE PRESENT. READ INSTRUCTIONS CAREFULLY BEFORE STARTING INSTALLATION.**
- Starting at the Passenger/Right side-front of the vehicle, remove the front factory body bolt & washer.(not re-used) **(Fig 1)**, From the list above select the Passenger/Right side front mounting bracket and the spacer Block secure to vehicle with (1) 12mm x 150mm Hex Bolt, (1) 12mm Flat Washer, (1) 12mm Lock Washers **(Fig 1A)**. Snug but do not tighten hardware at this time.
- Next, select the T Bolt from the list of parts above, and place the T Bolt into the opening on the Passenger/Right side bottom front frame rail **(Fig 2)** shows T Bolt placed into frame rail.
- Select the Passenger/Right side front brace bracket and fasten to front mounting bracket with (1) 10mm x 35mm Hex bolt, (2) 10mm flat washers, (1) 10mm lock washer and (1) 10mm nut, **(Fig 2A)** shows attachment, attach the other side of bracket to the T Bolt with (1) 10mm flat washer between bracket and T bolt (1) 10mm flat washer, (1) 10mm lock washer and (1) 10mm nut **(Fig 2B)** shows brace bracket attached to T bolt. Snug but do not tighten hardware at this time.
- Moving to the passenger/Right side rear of the vehicle, remove the rear factory body bolt (not re-used) From the list above select the Passenger/Right side rear mounting bracket and secure it with (1) 12mm x 150mm Hex Bolt, (1) 12mm Flat Washer, (1) 12mm Lock Washers **(Fig 3)** Shows bracket attached. Snug but do not tighten hardware at this time.
- Select the Passenger/right side Sidebar and fasten to the front mounting bracket with the included (1) 12mm x 50mm hex bolt, (1) 12mm lock washer, and (1) 12mm flat washer. Snug but do not tighten hardware at this time.
- Install rear of Sidebar to the rear mounting bracket with (1) 12mm x 50mm hex bolt, (1) 12mm lock washer, and (1) 12mm flat washer. Snug but do not tighten hardware at this time.
- Begin to install the bolt plate and the plastic retainer, pull the tape covering the factory hole on the inner rocker panel and thread the plastic retainer on the threads of the bolt plate place the bolt plate into the hole and tighten the plastic retainer against the rocker panel so the bolt does not fall in. **(Fig 4)** shows bolt plate attached to rocker panel.
- With the Bolt plate installed select the Passenger/right side middle brace bracket and secure it to the bolt plate with (1) 10mm flat washer, (1) 10mm lock washer and (1) 10mm nut **(Fig 5)** shows bracket attached secure the bottom of the bracket to the side bar with the (1) 10mm x 35mm hex bolt (1) 10mm flat washer and (1) 10mm lock washer. Snug but do not tighten hardware at this time
- Level and align Sidebar properly; then tighten all hardware at this time.
- Repeat steps 2-9 for Driver/left sidebar.
- Do periodic inspections to the installation to make sure all hardware is secure and tight.

To protect your investment, wax this product after installing. Regular waxing is recommended to add a protective layer over the finish. Do not use any type of polish or wax that may contain abrasives that could damage the finish.

For stainless steel: Aluminum polish may be used to polish small scratches and scuffs on the finish. Mild soap may be used also to clean the Sidebar.

For gloss black finishes: Mild soap may be used to clean the Sidebar.

FRONT PASSENGER SIDE

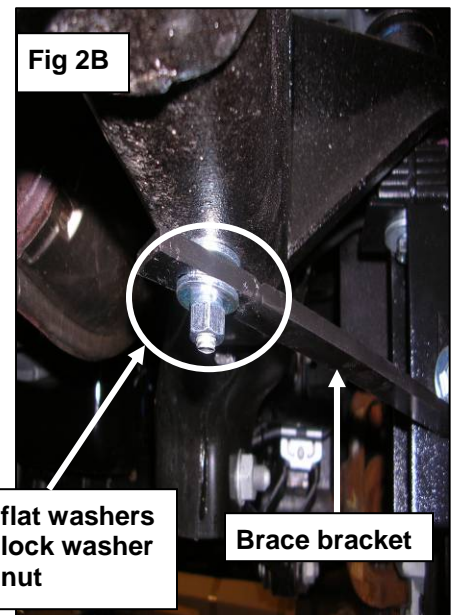
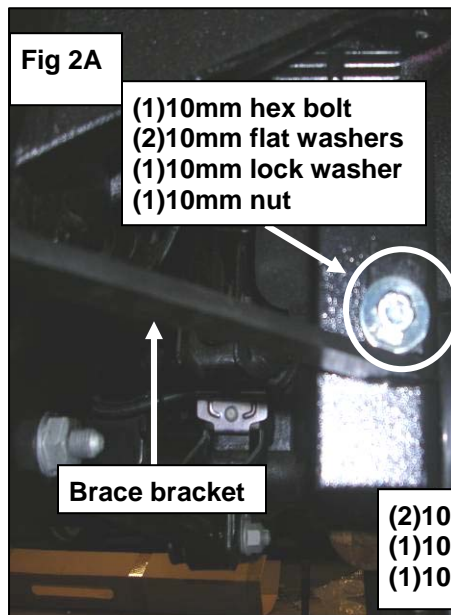
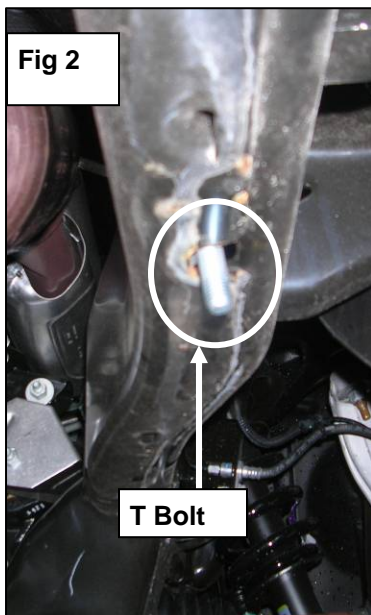
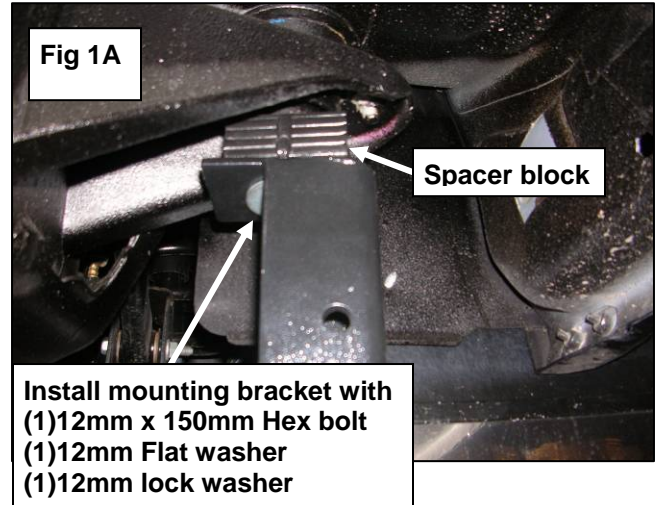
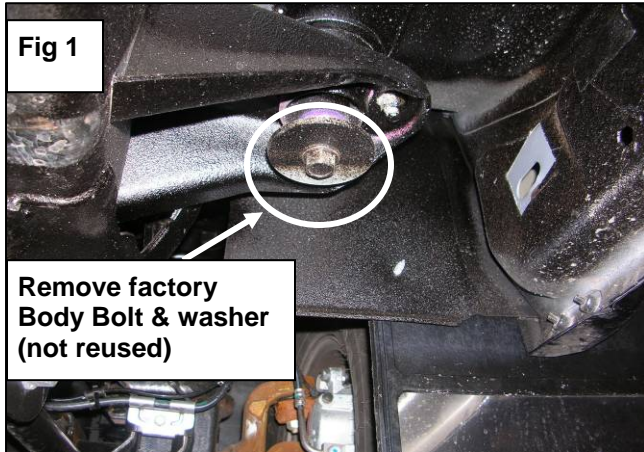

REAR PASSENGER SIDE

